



Installation Guide

Yeastar TA1600/2400/3200 V3
FXS VoIP Gateway

Version: 1.0

Updated: December 10, 2019

 Support: +86-592-5503301
 Support: support@yeastar.com
 <https://www.yeastar.com>

Contents

- Safety Disclaimers and Installation Warnings..... 3**
- Packing List..... 4**
- Hardware Overview..... 5**
 - TA1600 Hardware Overview..... 5
 - TA2400 Hardware Overview..... 6
 - TA3200 Hardware Overview..... 7
- Connect Yeastar TA Gateway..... 9**
- Connect Yeastar TA Gateway (Frame Ground)..... 10**

Safety Disclaimers and Installation Warnings

To avoid unexpected accident, personal injury or device damage, read the safety disclaimers and installation warnings.

Power

- Use only the power cord provided with the Yeastar TA device.
- Keep the power off during the installation.
- Make sure that the supply voltage matches the specifications indicated on the back panel of the device.
- To avoid the electric accident, do not open or remove the cover of device when it is working as well as off the power.
- Before cleaning the device, cut off the power supply.

Environment

Install the Yeastar TA device in a location that is clean, free from vibration, electric shock, and temperature/humidity extremes.

Table 1:

Environment	Requirement
Storage Temperature	-20 to 65°C, 4 to 149°F
Humidity	10% to 90% (non-condensing)
Operation Temperature	0 to 40°C, 32 to 104°F

Packing List

Upon receiving Yeastar TA 1600/2400/3200 gateway, you can open the package and check if all the items are supplied as per packing list.



Note: If there are any problems, contact your provider.

Table 2: TA1600/2400/3200 packing list

Item	Unit	QTY	Description
TA1600/2400/3200	PC	1	Device unit.
Power cord	PC	1	For the input of power.
RJ45 Ethernet cable	PC	1	-
Warranty card	PC	1	With serial number printed for repair & return.
Quick installation guide	PC	1	-
Mounting ears	PC	2	-
Mounting screws	PC	8	8 screws ($\phi 3.0 \times 6$ mm) for mounting ears.
Grounding stud and nut	Pair	1	-
Rubber feet	PC	4	-

Hardware Overview

TA1600 Hardware Overview

TA1600 front panel

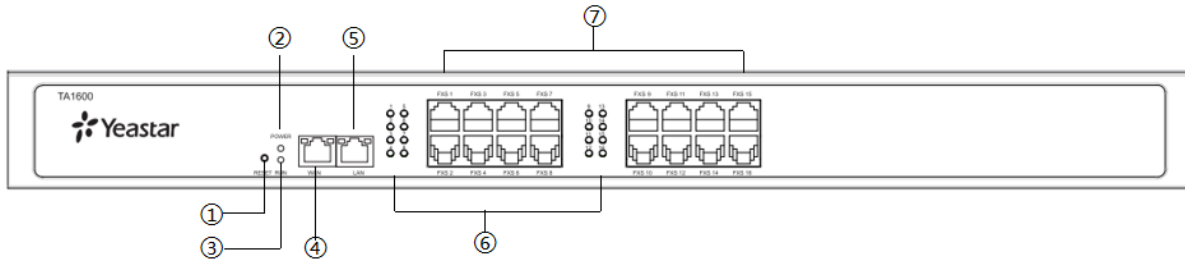



Table 3:

No.	Feature	Description
①	Reset Button	Press and hold for 7 seconds to reset to factory defaults.  Note: Do NOT press this button for a long time, or the system would break down.
②	Power LED	Indicates the power status. <ul style="list-style-type: none">• On: The power is switched on.• Off: The power is switched off.
③	RUN LED	Indicates the system status. <ul style="list-style-type: none">• Blinking: The system is working properly.• Not Blinking/Off: The system goes wrong.
④	WAN Port	10/100 adaptive RJ45 Ethernet port.
⑤	LAN Port	10/100 adaptive RJ45 Ethernet port.
⑥	FXS Ports Status	Indicates the FXS port status. <ul style="list-style-type: none">• Solid green: The port is idle or no line is connected to the port.• Green light blinking: There is a call reaches the port or the port is busy in a call.
⑦	RJ11 FXS Ports	For connection to analog phones or fax machines.

TA1600 back panel

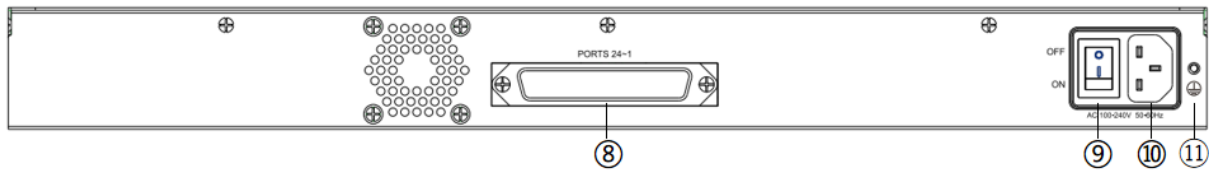

Table 4:

No.	Feature	Description
⑧	RJ21 FXS Ports	For connection to analog phones or fax machines with one RJ21 to RJ11 cable.
⑨	Power Switch	Press this button to switch on/off the device.
⑩	Power Inlet	Connect the power supply to the port.
⑪	Protective Earth	Protect the personnel and the equipment.

TA2400 Hardware Overview

TA2400 front panel

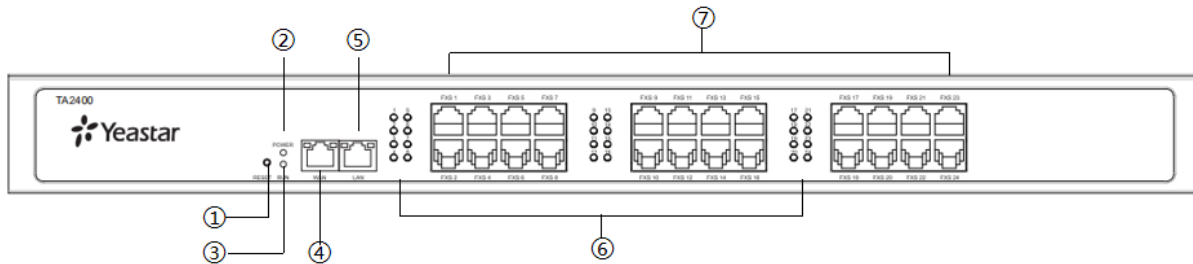



Table 5:

No.	Feature	Description
①	Reset Button	Press and hold for 7 seconds to reset to factory defaults.  Note: Do NOT press this button for a long time, or the system would break down.
②	Power LED	Indicates the power status. <ul style="list-style-type: none"> • On: The power is switched on. • Off: The power is switched off.
③	RUN LED	Indicates the system status. <ul style="list-style-type: none"> • Blinking: The system is working properly. • Not Blinking/Off: The system goes wrong.

No.	Feature	Description
④	WAN Port	10/100 adaptive RJ45 Ethernet port.
⑤	LAN Port	10/100 adaptive RJ45 Ethernet port.
⑥	FXS Ports Status	Indicates the FXS port status. <ul style="list-style-type: none"> • Solid green: The port is idle or no line is connected to the port. • Green light blinking: There is a call reaches the port or the port is busy in a call.
⑦	RJ11 FXS Ports	For connection to analog phones or fax machines.

TA2400 back panel

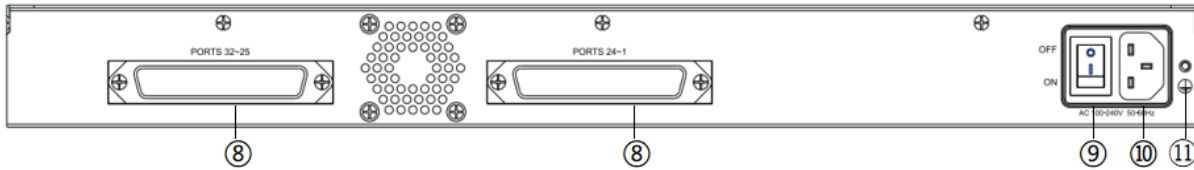

Table 6:

No.	Feature	Description
⑧	RJ21 FXS Ports	For connection to analog phones or fax machines with one RJ21 to RJ11 cable.
⑨	Power Switch	Press this button to switch on/off the device.
⑩	Power Inlet	Connect the power supply to the port.
⑪	Protective Earth	Protect the personnel and the equipment.

TA3200 Hardware Overview

TA3200 front panel

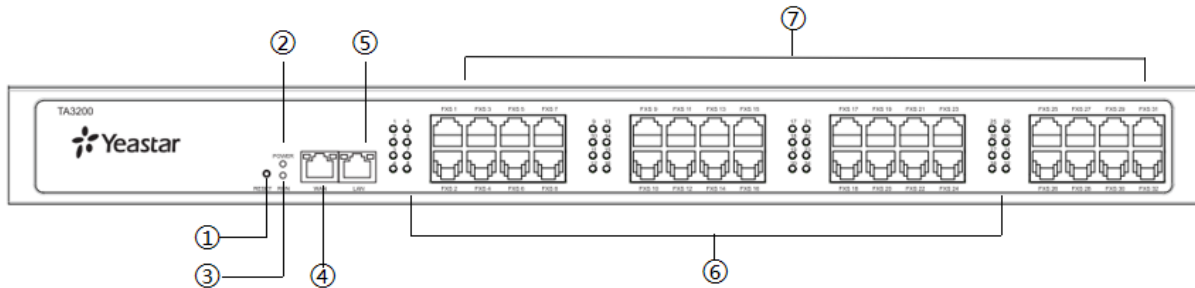



Table 7:

No.	Feature	Description
①	Reset Button	Press and hold for 7 seconds to reset to factory defaults.  Note: Do NOT press this button for a long time, or the system would break down.
②	Power LED	Indicates the power status. <ul style="list-style-type: none"> • On: The power is switched on. • Off: The power is switched off.
③	RUN LED	Indicates the system status. <ul style="list-style-type: none"> • Blinking: The system is working properly. • Not Blinking/Off: The system goes wrong.
④	WAN Port	10/100 adaptive RJ45 Ethernet port.
⑤	LAN Port	10/100 adaptive RJ45 Ethernet port.
⑥	FXS Ports Status	Indicates the FXS port status. <ul style="list-style-type: none"> • Solid green: The port is idle or no line is connected to the port. • Green light blinking: There is a call reaches the port or the port is busy in a call.
⑦	RJ11 FXS Ports	For connection to analog phones or fax machines.

TA3200 back panel

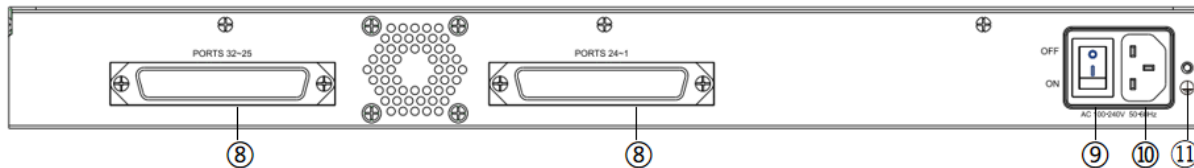
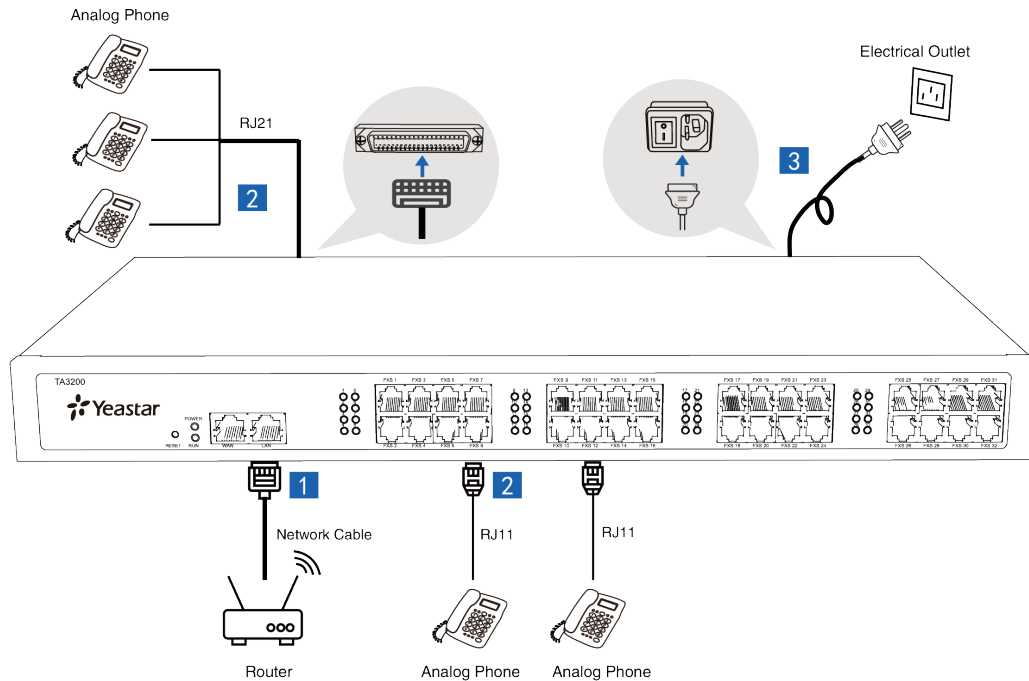

Table 8:

No.	Feature	Description
⑧	RJ21 FXS Ports	For connection to analog phones or fax machines with one RJ21 to RJ11 cable.
⑨	Power Switch	Press this button to switch on/off the device.
⑩	Power Inlet	Connect the power supply to the port.
⑪	Protective Earth	Protect the personnel and the equipment.

Connect Yeastar TA Gateway

Follow the steps to connect Yeastar TA1600/2400/3200 FXS VoIP gateway.



1. Connect TA gateway to the Internet

LAN port can be connected to router or PBX.

2. Connect TA gateway to analog phones

FXS ports can be connected to analog phones.

3. Power on TA gateway

Connect one end of the power cord to the gateway's power port; plug the other end into an electrical outlet.

Connect Yeastar TA Gateway (Frame Ground)

Yeastar TA1600/2400/3200 FXS VoIP gateway supports ground protection. Follow the instructions to connect the TA gateway to the ground.

Warning:

- The ground wire must be installed by the service person.
- Proper grounding (connection to ground) is very important to reduce the risk to the user of electrocution or to protect the TA device from the bad effects of external noise in the case of a lightning strike.
- A permanent connection between ground and the ground terminal of the TA device must be made.

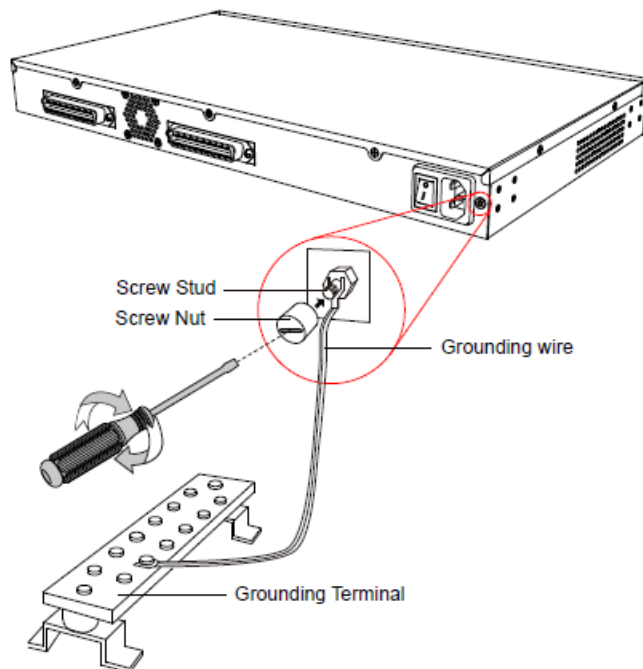

1. Tighten the provided M3*5 screw stud into the grounding port on TA device.
2. Insert an 18AWG grounding wire (user-supplied).
3. Tighten the provided M3 screw nut using a straight screwdriver.
4. Attach the grounding wire to the grounding terminal.