

## FriendlyELEC NanoPi NeoCore - 512MB 8GB EMMC QuadCore

>>> [Al artículo de la tienda](#)

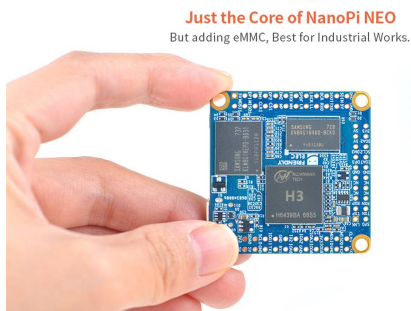

### EAN CODE



FriendlyELEC NanoPi NeoCore - 512MB 8GB EMMC QuadCore Allwinner H3 Quadcore A7 1,2ghz

Passenden Kühlkörper für den Prozessor (Art. 134871) bitte extra dazubestellen.

- SoC: Allwinner H3 Quad Core Cortex A7 1,2Ghz
- DDR3 RAM: options: 512M RAM 8GB EMMC
- MicroSD Slot x1
- Power: DC 5V/2A
- PCB Dimension(mm): 40x40mm
- OS/Software: u-boot, Ubuntu-Core

**Just the Core of NanoPi NEO**  
 But adding eMMC, Best for Industrial Works.

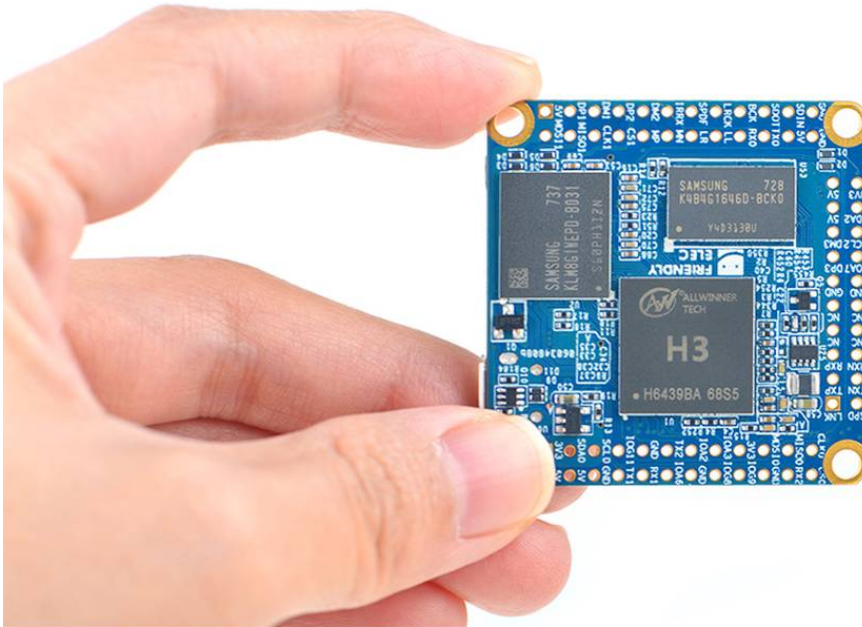

Quad-Core  
affordable price



256MB/512MB  
Optional



0/8GB/16GB/32GB  
Optional



Up to 64GB  
Bootable from TFcard



Power input  
from MicroUSB



Compatible with  
NEO modules



Mainline  
UbuntuCore



40\*40mm  
size

**- Introduction**

The NanoPi NEO Core as its name tells is an alternative NanoPi NEO that works like a CPU board with male pin-headers. It has the same form factor as the NanoPi NEO, same pin descriptions and works with all the OS images the NanoPi NEO supports. The connectors and ports on the NEO are populated to pin-headers on the NEO Core. In addition the NEO Core can have an optional onboard eMMC flash which is preferred by industrial customers.

The NEO Core uses a popular Allwinner H3 SoC and has onboard 256M/512M DDR3 RAM. FriendlyElec offers models with three eMMC options: 8GB/16GB/32GB and one that doesn't have eMMC at all. FriendlyElec migrated UbuntuCore with mainline kernel 4.11 for it. Compared to the NanoPi NEO the NanoPi NEO Core has optimized power circuit design and runs more reliably with much less overheat. NEO Core's CPU temperature didn't exceed 30 degrees in Celsius in our tests in regular situations.

FriendlyElec develops a Mini Shield for NanoPi NEO Core/Core2 which has the same form factor as the RPI 3. When a NanoPi NEO Core is connected to this Mini Shield the whole assembled module can be well fit into a common RPI 3's case.

- Layout & Interface

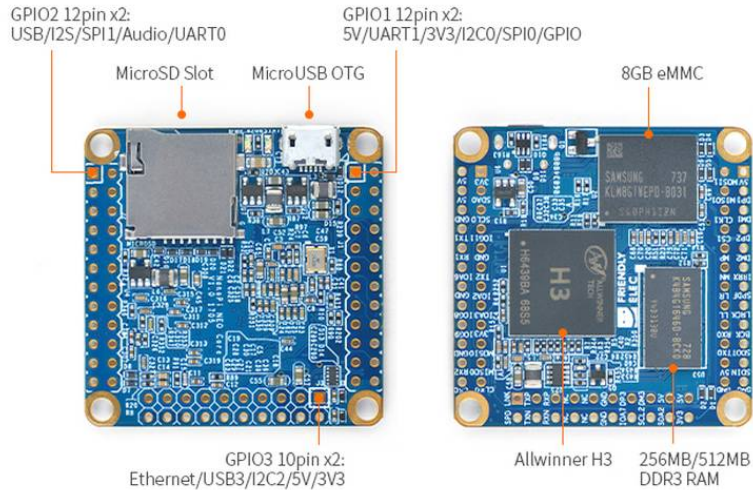

NanoPi NEO Core pinout diagram

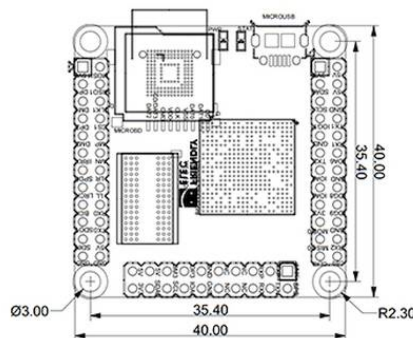
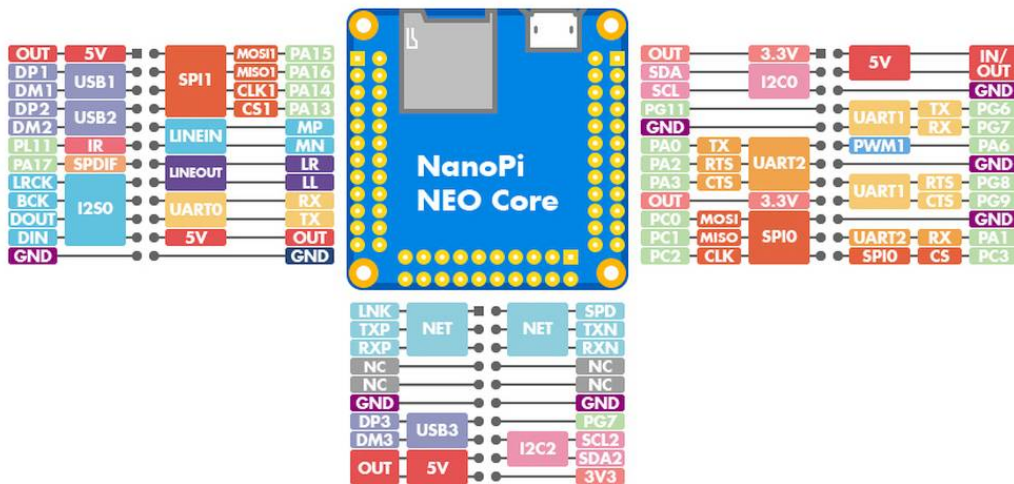



Número de artículo: 150540  
Número de fabricante: FE-NeoCoreno-pins

#### - Hardware Spec

CPU	Model: Allwinner H3 Number of Cores: Quad-core Frequency: 4*Cortex-A7 Up to 1.2GHz
Memory	RAM: 256MB/512MB DDR3 RAM
Storage	eMMC: 0/8GB/16GB/32GB MicroSD Solt: MicroSD*1 for external storage up to 64GB
Connectivity	Ethernet: 10/100M Ethernet (6Pin, included in 2.54mm pitch pin header)
Audio	input/output Port (4Pin, included in 2.54mm pitch pin header)
USB	MicroUSB*1: Power & OTG USB Host*3 (included in 2.54mm pitch pin header)
Pin-header	GPIO: two 2.54mm spacing 12x2pin header,one 2.54mm spacing 10x2pin header It includes UART, SPI, I2C, USB, I2S, Ethernet, GPIO etc.
LED	Power LED*1 State LED*1
Others	Working Temperature: -40°C to 80°C
Power	DC 5V/2A

#### - OS/Software

OS Support	FriendlyCore(based on UbuntuCore) and uboot, Armbian, DietPi, Lakka, Kali, OpenWrt etc
------------	----------------------------------------------------------------------------------------

#### - Dimension

PCB	Six Layer
Dimension	40mm*40mm
Weight	6.35g(WITHOUT Pin-headers)

- Application

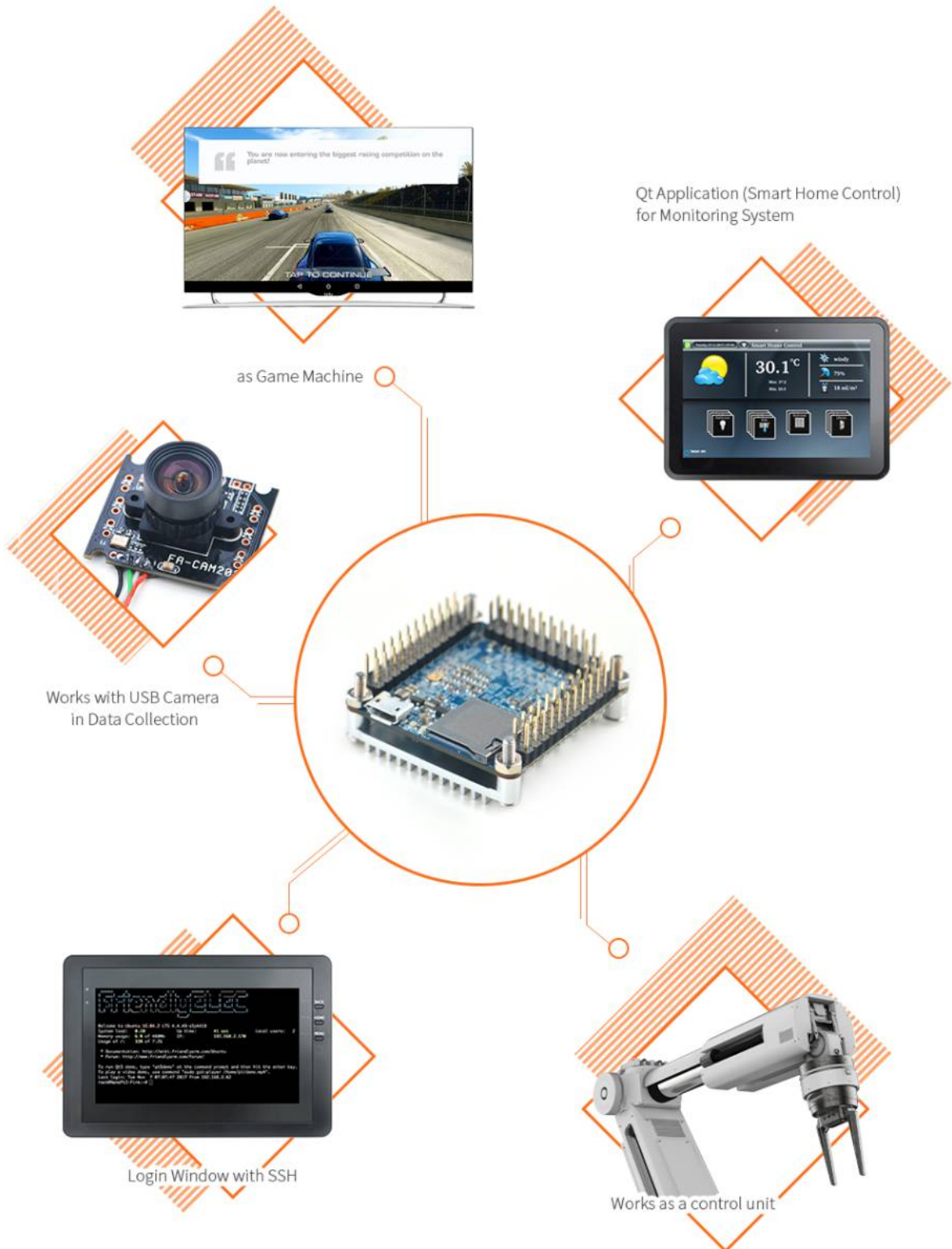

- Gallery

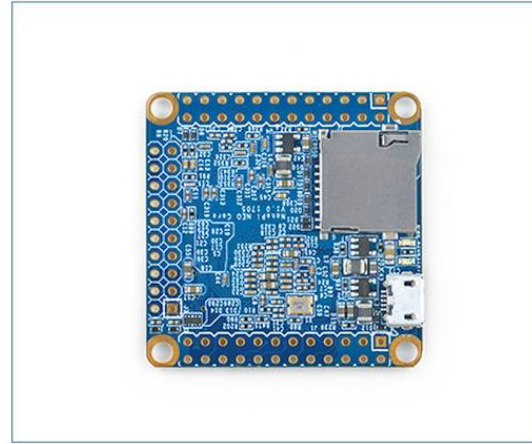
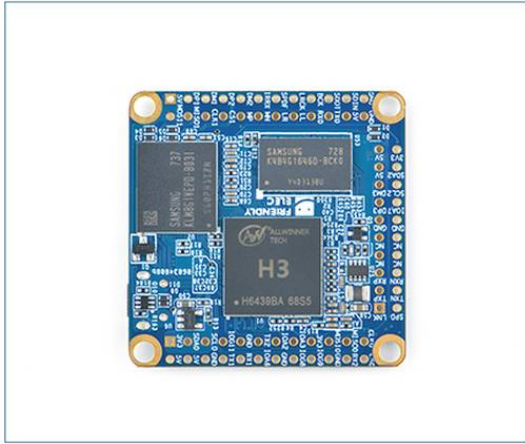

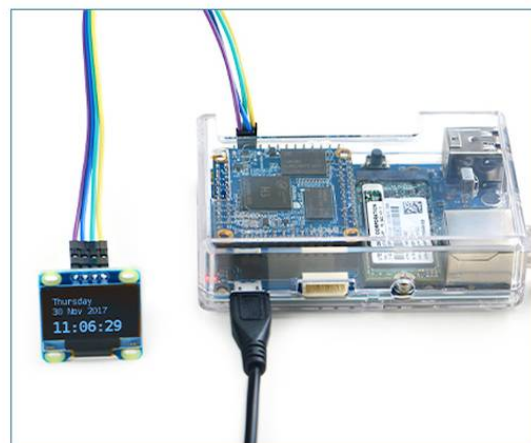
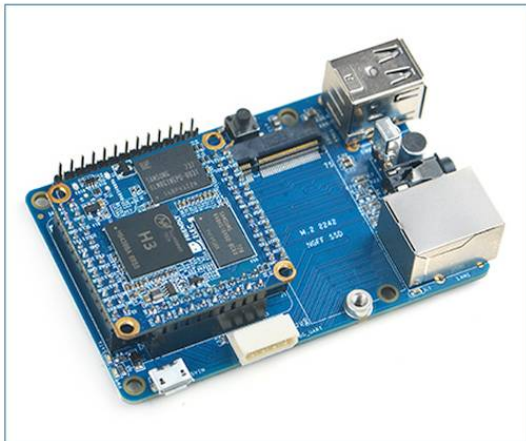
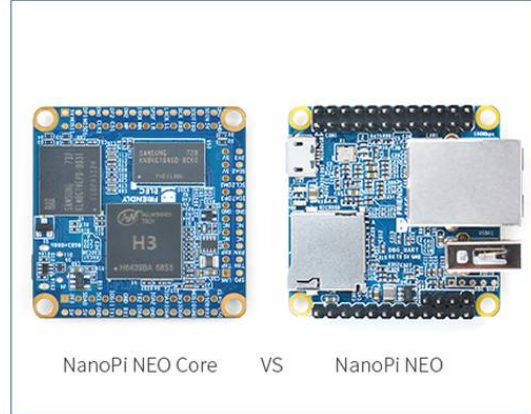
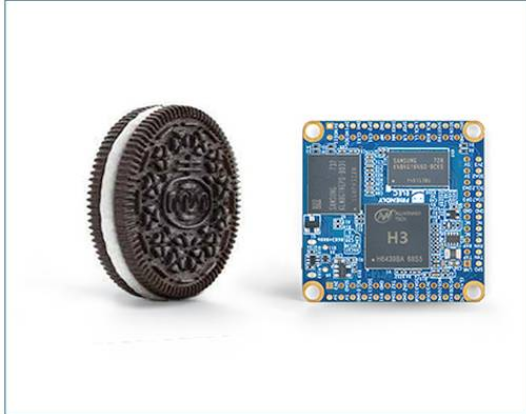

### - Shipping List

- 1 x NanoPi NEO Core
- 2 x double-row 24-pin header
- 1 x double-row 20-pin header

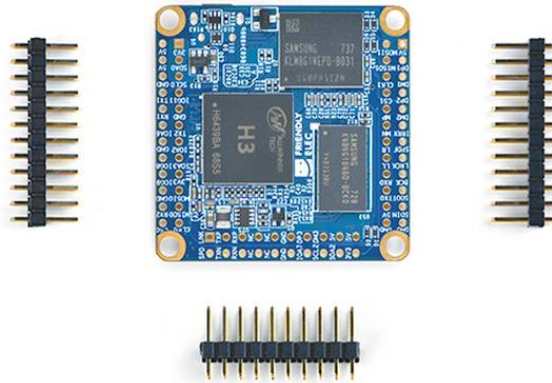

## Accesorios

Número de artículo	Denominación
138311	FriendlyELEC NanoPi Neo zbh. Power Dock
139009	FriendlyELEC NanoPi Neo zbh. NanoHat Audio Shield PCM5102A
134872	FriendlyELEC NanoPi TTL To RS232 - Serielle Schnittstelle
134871	FriendlyELEC Refrigeración para Neo/Neo2
134875	FriendlyELEC UART GPS NEO-7M Module Matrix GPS Module
134874	FriendlyELEC FA-CAM202 2M-Pixel USB Camera for NanoPi2, Plug
134873	FriendlyELEC LCD1602 Keypad - I2C interface, User Keys
124147	ALLNET Fuente de alimentación Micro USB 5V/2A
124479	EMTEC Tarjeta de Memoria microSDHC UHS-I 8GB
124768	Flash SecureDigitalCard (SD) 32GB *Kingston* microSDHC
114461	Synergy 21 S215456 Cable USB2.0 (m) > MicroUSB (m), 1m texti
114463	Synergy 21 S215458 Cable USB2.0 (m) > MicroUSB (m), 1m texti
114470	Synergy 21 S215465 Cable USB2.0 (m) > MicroUSB (m), 2m texti
114471	Synergy 21 S215466 Cable USB2.0 (m) > MicroUSB (m), 2m texti
162778	ALLNET Adaptador cable extensión MicroSD - MicroSD