

ITEM NO	COLOUR
S216322	pure white, RAL9010
S216323	pearl white, RAL1013

Materials:

Outlet Housing: ABS /UL94V2
 Outlet Base: ABS /UL94V2
 Metallic Plate: Al&Zn Alloy /Al&Zn Alloy,
 PACKING: 1pcs/PE bag+label 1, 12pcs/box+label 2, 120pcs/ctn+label 1
 RoHS 2.0 And REACH Compliant

SYNERGY 21										
CUSTOMER		ITEM NO.		See The Chart						
		UPDATE PACKING TYPE	2018-03-20	A1	PRODUCT NAME	Face plate 1 port	manufacture country	China	UNIT	MM
		NEW	2016-10-11	A	DRAWNBY	CHECKBY	APPOBY	DATE		
BY	CHK	REVISION RECORD MODIFICATIONS	DATE	REV.	SYNERGY 21	SYNERGY 21	SYNERGY 21	2018-03-20		

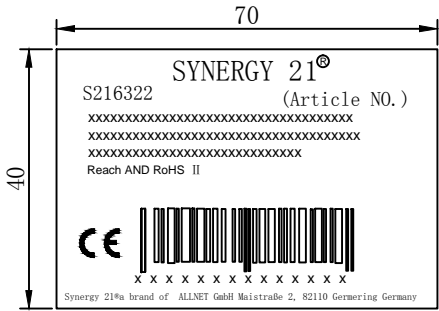

Label 1

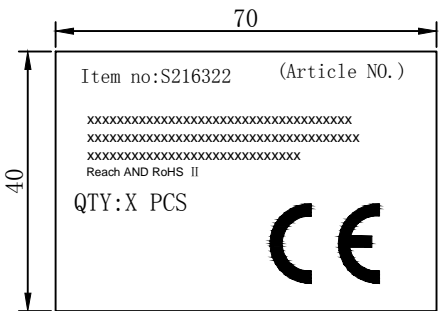

label 2

SHIPPING MARK



PO NO. :
REACH and ROHS 2.0 Compliant
MADE IN CHINA

SIDE MARK

PO NO. :
Item no:
Q' TY:
N. W
G. W
Carton no.
MEAS.

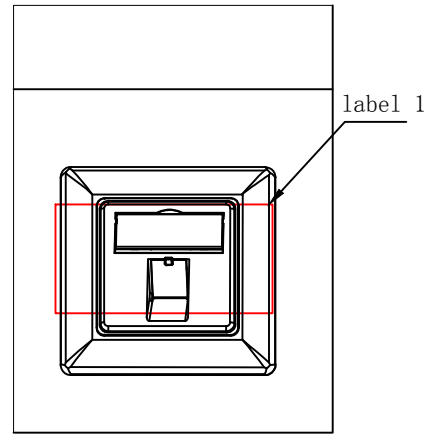

1PCS/PE bag+label1

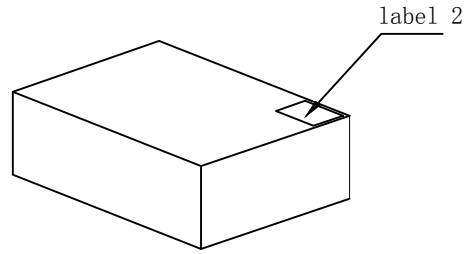
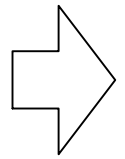

12pcs/box+label2

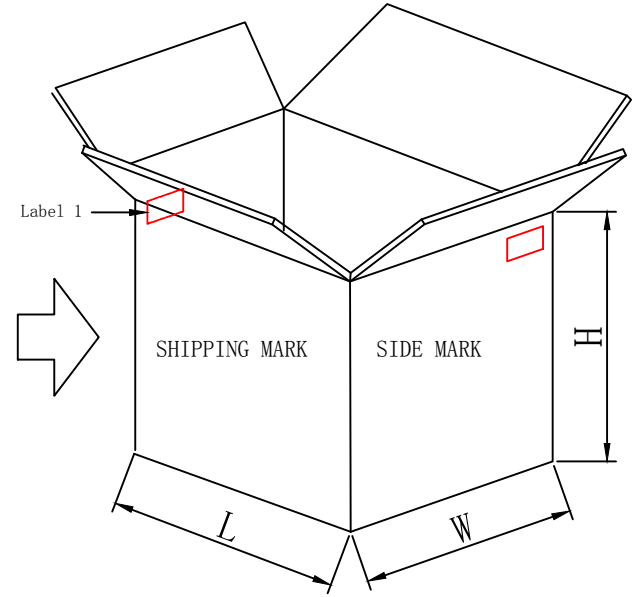
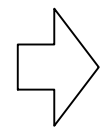

120pcs/ctn+label 1

- NOTE:
- 1.pcs/PE bag+label 1, 12pcs/box+label 2, 120pcs/ctn+label 1
 2. “工” type sealing
 3. “井” type packaging

SYNERGY 21									
CUSTOMER						ITEM NO.		See The Chart	
PRODUCT NAME		PACKING	manufacture country:		china	UNIT		MM	
DRAWNBY			CHECKBY			APPOBY		DATE	
SYNERGY 21		SYNERGY 21		SYNERGY 21		SYNERGY 21		2018-03-20	

		UPDATE PACKING TYPE		2018-03-20	A1
		NEW		2014-09-25	A
BY	CHK	REVISION RECORD MODIFICATIONS		DATE	REV.

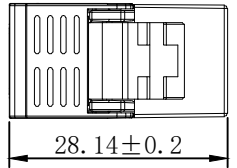
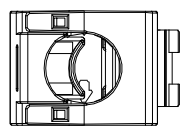
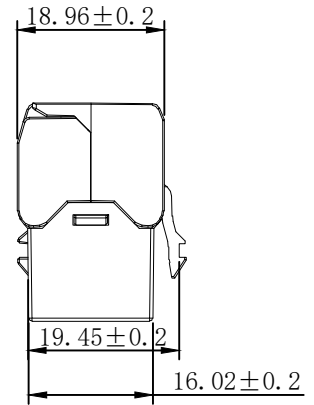
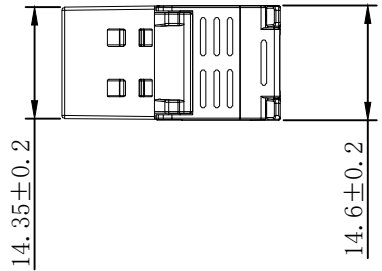

NOTE:

ELECTRICAL

1. Contact Resistance :200Ω MAX
2. Insulation Resistance :500Ω MIN @ 500V DC
3. Withstand Voltage :DC 1000V AC 700V RMS 60Hz, 1MIN

ENVIRONMENTAL:

Storage : -40°C TO +70°C
 Operation: -10°C TO +60°C

MECHANICAL

1. SHIELD MATERIAL: ZINC ALLOY (Silver)
2. IDC MATERIAL: PC UL94V0 TERMINAL: PHOSPHOR BRONZE, TIN PLATING
3. RJ45 Contact Life: 750 Times Min
4. Plug in force: <30N
5. Solid cable: 1/22AWG (0.65MM) - 1/24AWG (0.45MM) ID: 0.8MM - 1.6MM
6. Cable OD: 5.0mm - 8.5mm
7. PoE per IEEE 802.3af, PoE+ per IEEE 802.3at

MATERIAL LIST:

⑦	IDC TERMINAL	FOR 22-24AWG (0.45mm-0.65mm) CABLE	1	
⑥	LABEL COLOR CODE	T568A/B	2	
⑤	IDC PIN	PHOSPHOR BRONZE & TINNED	8	
④	IDC BODY	FIREPROOF/PC UL 94V0	1	
③	PCB	1.2mm UL 94V0	1	
②	RJ-45 JACK INSERT	PHOSPHOR BRONZE 8P8C GOLD PLATED	8	
①	MODULAR COVER	ZINC ALLOY	1	
NO.	PARTS NAME	SPECIFICATION DESCRIPTION	QT'Y	REMARK
		NEW	2022-09-30	A
BY	CHK	REVISION RECORD MODIFICATIONS	DATE	REV.

Fluke Test: Permanent Link ISO 11801 (PL 2) Class Ea
 RoHS 3.0 and REACH Compliant
 Packing: 1pc+copper foil/PE bag+label

SYNERGY21

CUSTOMER		ITEM NO.	S216380		
PRODUCT NAME	CAT. 6A FTP KEYSTONE JACK	manufacture country:	CHINA	UNIT	MM
DRAWNBY	CHECKBY	APPOBY	DATE		
SYNERGY21	SYNERGY21	SYNERGY21	2022-09-30		

Installationsanleitung/Installation guide

Keystone Jack

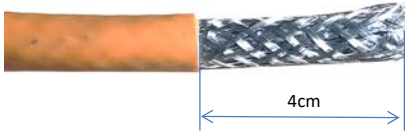

①.Stripping 4cm of sheath.



②.foldback braided and drained wire.



③.paste copper foil on the braided and ground wire and cut off the excess weave and the ground wire



④.4.Fan out all four twisted pairs, allocate each by following colorcoding label



⑤.Across the holde by the color marks of T568A or T568B

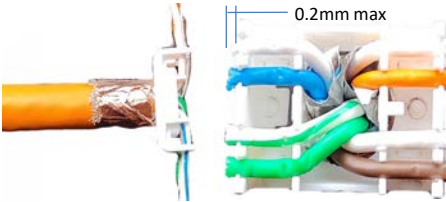

⑥. allocate each conductor into proper slots on wiring cap by following color coding



⑦.Trim the theends of conductors.

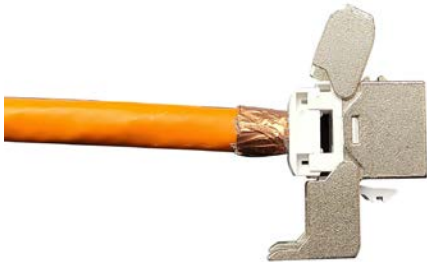

⑧.install the termination cap in direction of arrow into the keystone jack



⑨.press both covers of the keystone jack to contact the cable



⑩.Press down the retainer for 360 degree shielding