

MATERIAL LIST:

- 1.wall box: ABS
- 2. Accessories  
 cable tie: 4 PCS 2.5\*80MM  
 SCRW: 2PCS ST4\*20MM
- 3.Applicable cable diameter:OD 8.2MM Max
- 4. ROHS 2.0 AND REACH COMPLIANT

SYNERGY 21										
CUSTOMER				ITEM NO.		S216342				
PRODUCT NAME			4 port wall box		manufacture country:		CHINA		UNIT	MM
NEW			2017-04-21		A		DRAWNBY		CHECKBY	
BY			CHK		REVISION RECORD MODIFICATIONS		DATE		REV.	
SYNERGY 21			SYNERGY 21		SYNERGY 21		SYNERGY 21		2017-04-21	

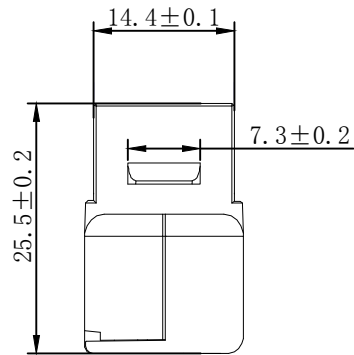
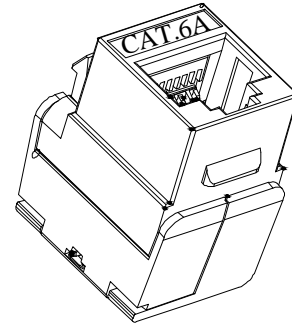
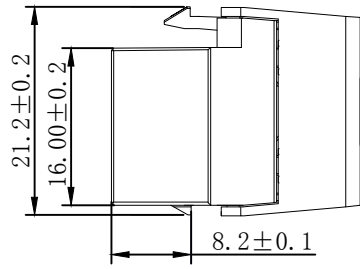
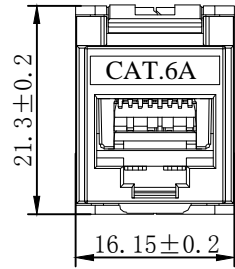

NOTES:

ELECTRICAL:

1. Contact Resistance : 20MΩ MAX
2. Insulation Resistance : 500MΩ MIN @ 500V DC
3. Withstand Voltage : DC 1000V AC 700V RMS 60Hz, 1MIN
4. Component testing for Cat.6A to ISO/IEC 11801 Ed.2.2:2011-06  
 DIN EN 50173-1:2011-09  
 TIA/EIA-568-C.2 (2009-08)  
 IEC 60603-7-5
5. Compliance with Class EA up to 500 MHz to ISO/IEC 11801 Ed.2.2:2011-06  
 DIN EN 50173-1:2011-09

ENVIRONMENTAL:

1. Storage : -40° TO+70°
2. Operation : -10° to+60°

MECHANICAL

1. SHIELD MATERIAL: ZINC ALLOY
2. IDC MATERIAL: PC TERMINAL:PHOSPHOR BRONZE, TIN PLATING
3. RJ45 Contact Life: 750 Times Min
4. Plug inforce:<30N
5. Solid cable:1/22AWG(0.65MM)-1/24AWG(0.45MM) ID:0.8MM-1.6MM
6. Cable OD: 5.0mm-8.5mm
7. PoE per IEEE 802.3af, PoE+ per IEEE 802.3at

Fluke Test:Permanent Link ISO 11801 (PL2)Class Ea 1000MHZ  
 AWG23/1 CAT.7 Shielded 15M  
 RoHS(EU2015/863) and REACH Compliant  
 PACKING:1PCS/PE BAG

MATERIAL LIST:

⑦	MODULAR COVER	White/PC with T568A/B label	1	
⑥	RJ 45 JACK INSERT	PHOSPHOR BRONZE 8P8C 6U" GOLD PLATED	8	
⑤	PCB	1.6mm UL 94V0	1	
④	IDC BODY	White/PC	1	
③	IDC PIN	PHOSPHOR BRONZE & TINNED	8	
②	LABEL COLOR CODE	T568A/B	2	
①	IDC TERMINAL	FOR 22-24AWG(0.45mm-0.65mm) CABLE	1	
NO	PARTS NAME	SPECIFICATION STANDARD	QT'Y	REMARK

		NEW	2019-05-09	A
BY	CHK	REVISION RECORD MODIFICATIONS	DATE	REV.

SYNERGY 21					
CUSTOMER			ITEM NO.	S216349	
PRODUCT NAME	CAT.6A STP KEYSTONE JACK	manufacture country:	china	UNIT	MM
DRAWNBY		CHECKBY		APPOBY	DATE
SYNERGY 21		SYNERGY 21		SYNERGY 21	2019-05-09

# Montageanleitung/Installation Instruction

## Super short body Cat.6A Keystone Jack

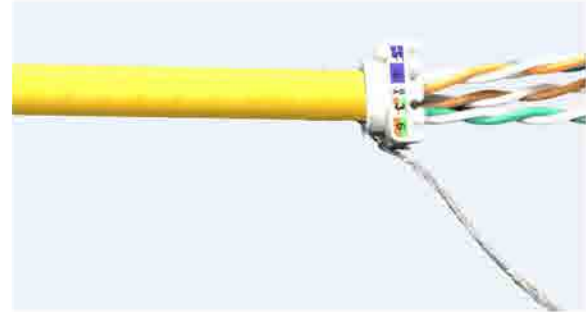
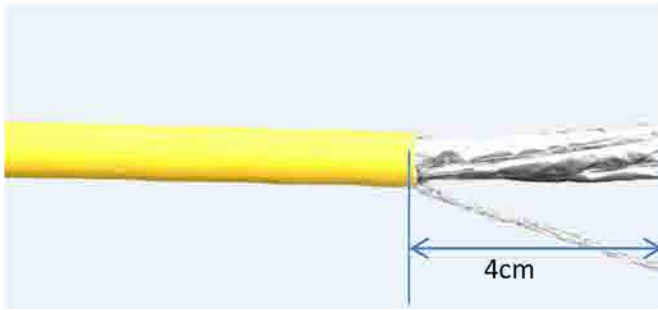

①. Stripping off approx. 4cm, twist the braiding into a strand.  
Remove the pair shielding.

②. Pass the cable wires into grommet without the strand  
as shown in the photo.

①. Ca. 4 cm abziehen und das Geflecht zu einer Litze  
verweben. Entfernen Sie die Paarabschirmung.

②. Führen Sie die Kabeldrähte ohne die Litze in die  
Durchführung ein (siehe Foto).

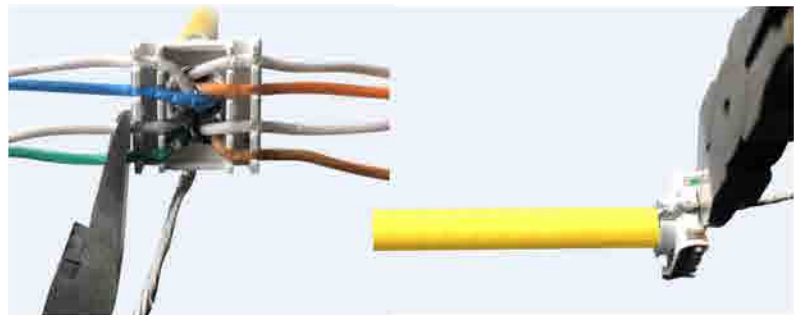
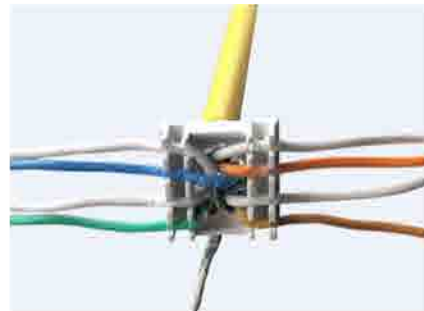

③. Insert each wire in its location  
according to the color code.

④. Cut the wires and the strand.

③. Legen Sie jeden Draht gemäß  
dem Farbcode an seiner Stelle ein

④. Schneiden Sie die Drähte und die Litze ab.



⑤. Make sure that the arrows of the jack are oriented in the same direction as those of the grommet.

⑤. Stellen Sie sicher, dass die Pfeile des Wagenhebers in die gleiche Richtung wie die der Tülle zeigen.

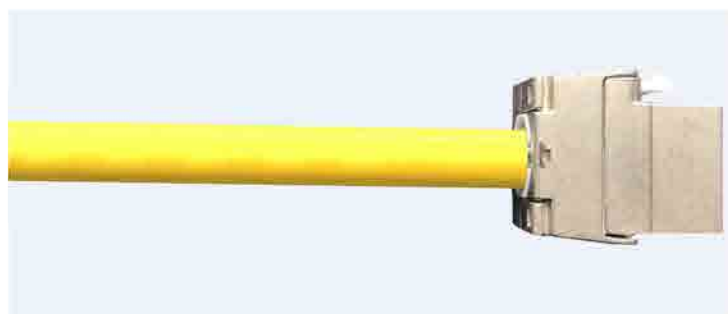

⑥. Connect the grommet to the connector.

⑦. Fold the cheeks of the RJ45 jack until completely closed.

⑥. Verbinden Sie die Tülle mit dem Anschluss.

⑦. Falten Sie die Wangen der RJ45-Buchse, bis sie vollständig geschlossen sind.