

ALLNET Antennas 868MHz 12.5dbi Antenna (N-Fem.) YAGI ANT-868



EAN CODE



ALLNET Antennas 868MHz 12.5dbi Antennas (N-Female) YAGI ANT-868-12.5dbi-Yagi LoRA HELIUM IoT

Highlights:

- 860~896MHz Yagi Antenna 6 Elements
- Gain: 12.5dbi (See table for more details)
- Coverage angle: 42°/39° (see table for more details)
- Impedance: 50 Ohm
- VSWR: <=1.4
- Connector: N-type female (suitable connection cables can be found in the accessories)
- Dimension: Length = 941x202x55mm
- Windspeed: 200km/h
- Temperature: -45°C ~ +75°C
- Mounting: Mast mounting
- Package contents: Antenna and mounting accessories
- Ideal for LoRA / Helium Network / Helium Miner / IoT terminals / 868MHz systems etc.

Yagi antennas belong to the group of longitudinal radiators and use radiation-excited elements. Yagi antennas consist of a group of active and passive (parasitic) elements which produce a common strongly pronounced directional pattern through mutual co-coupling. They often consist of only one fed element with a number of parasitic radiation-fed elements.

Heavy Duty Construction. High gain for excellent point to point. Narrow beamwidth and High F/B ratio minimize other system interference



Technical Details:

Model	ANT-868-10dbi-Yagi	ANT-868-12.5dbi-Yagi	ANT-868-14dbi-Yagi
Electrical Specification	WideBand: 806-896MHz		
Polarization	Vertical Polarized / Horizontal Polarized		
Max Gain	10dbi	12.5dbi	14dbi
H Beamwidth (-3dB, V-Pol)	73° ± 7°	42° ± 5°	33° ± 5°
E Beamwidth	55° ± 5°	39° ± 3°	30° ± 5°
VSWR	<1.4		
Nominal Impedance	50 ohm		
F/B Ratio	>15dB	>17dB	>20dB
Max Power	100watts		
Mechanical Specification			
Connector	N-Female		
Radome	Fiberglass, Dia 20mm		
Color	White/Grey		
Dimension	582 * 202 * 55mm	941 * 202 * 55mm	1297 * 202 * 55mm
Weight incl Mount Kit	0.7kg	0.9kg	1.2kg
Max windload	200km/h, 125mph		
Working Temperature Range	-45°C to +75°C		
Storage Temperature	-50°C to +75°C		

Antenna Test Data:

2D Radio Pattern Model: ANT-868-10dbi-Yagi 6 Elements

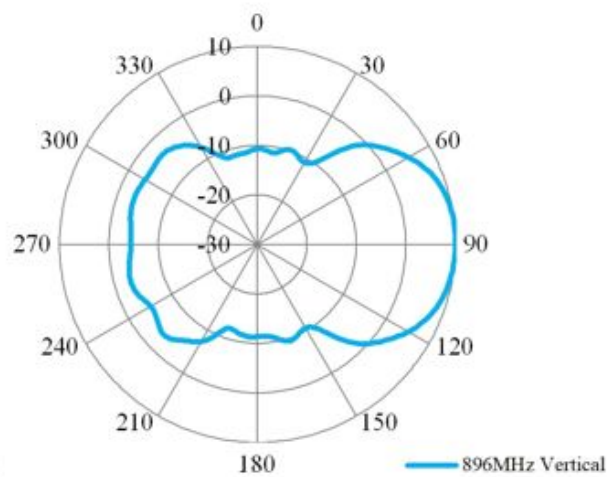
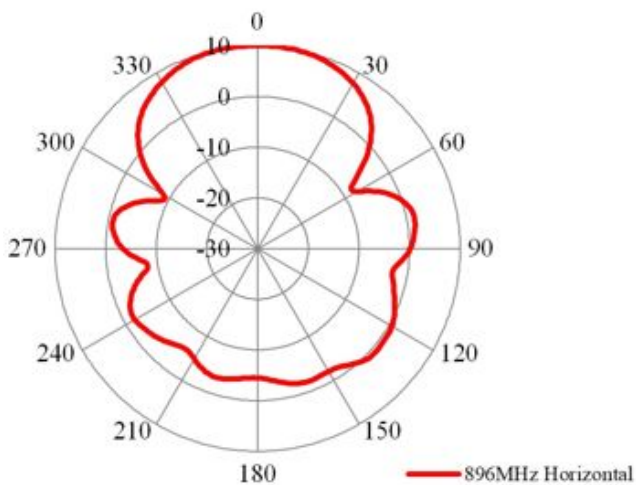
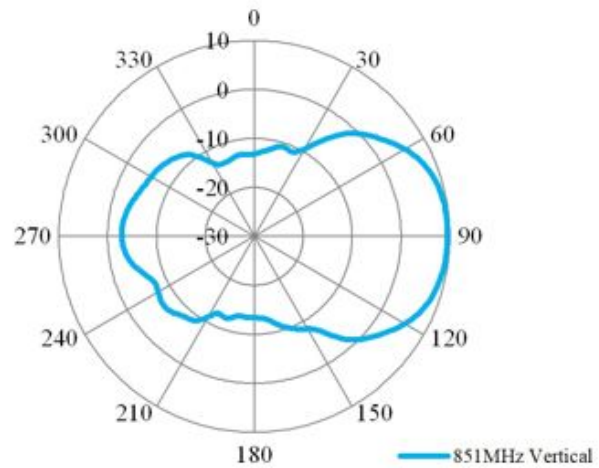
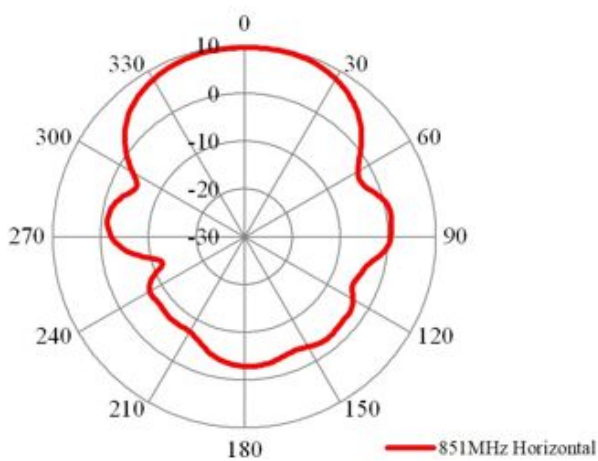
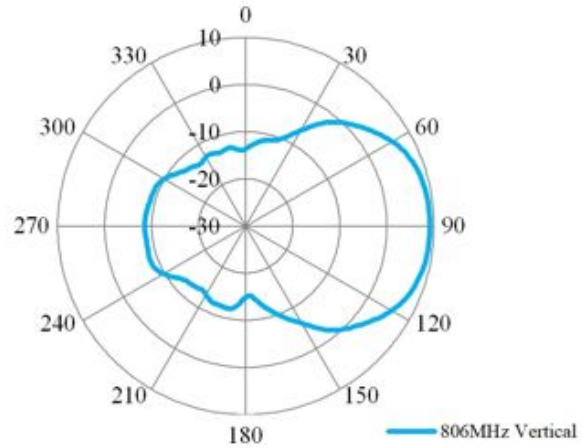
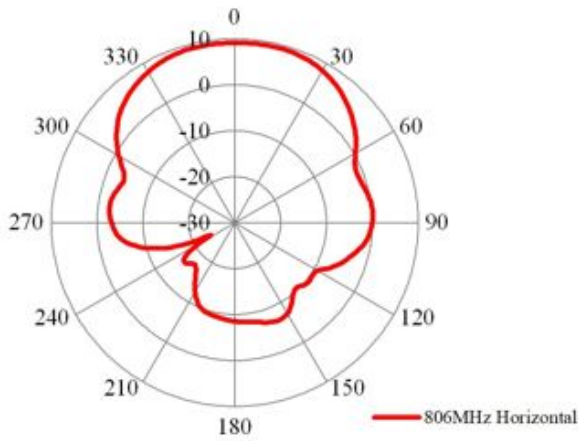

VSWR and Return Loss Model: ANT-868-12.5dbi-Yagi 10 Elements

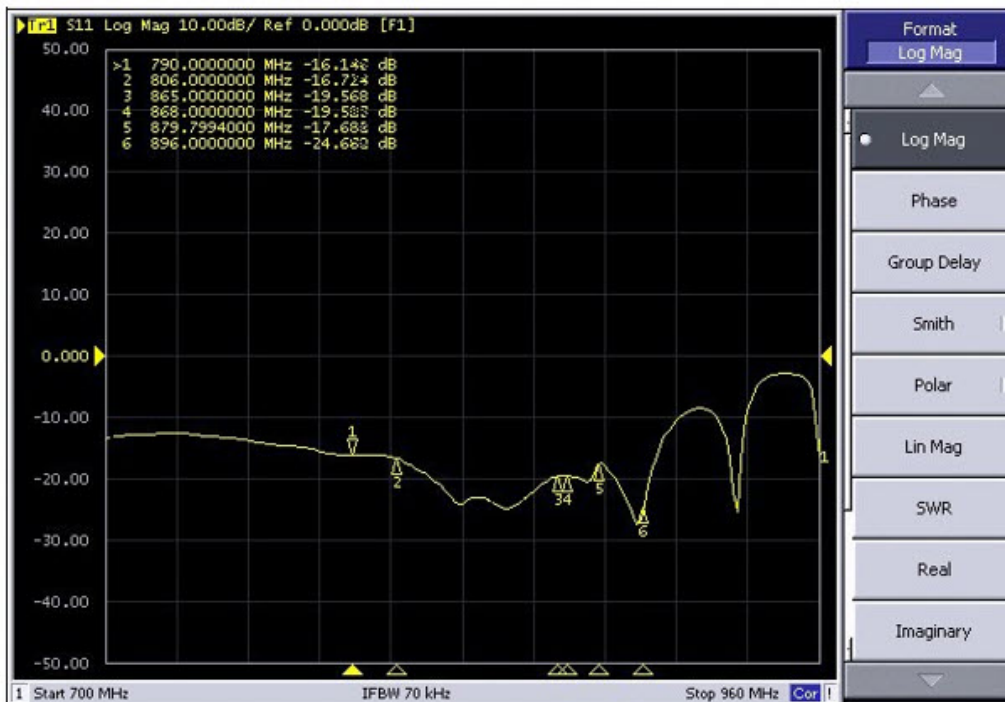
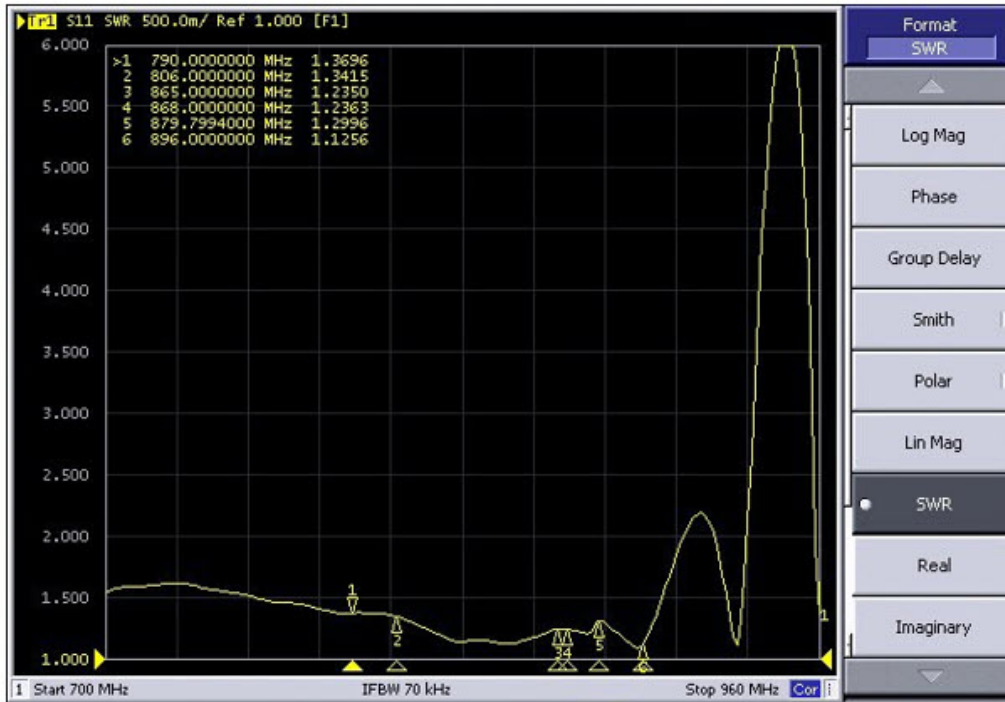



No. d'article: 208619
Numéro de fabricant: ANT-868-12.5dbi-Yagi

Mechanical Dimmension:

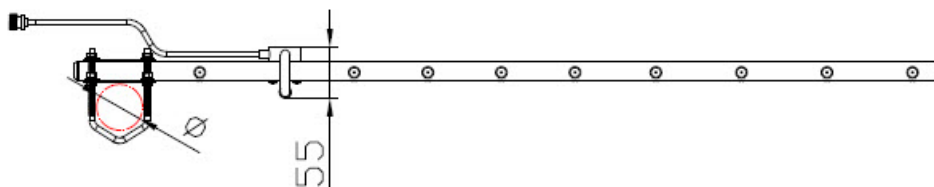
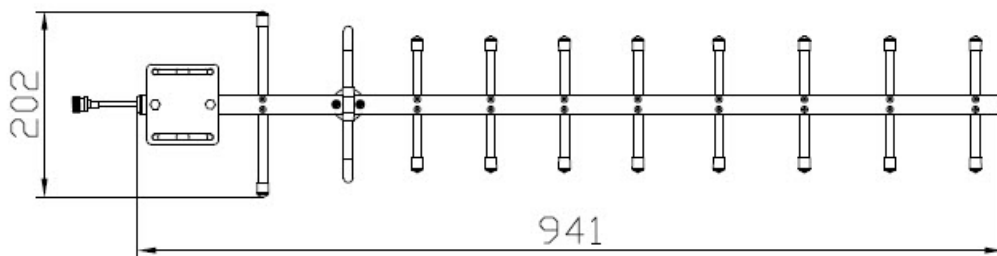
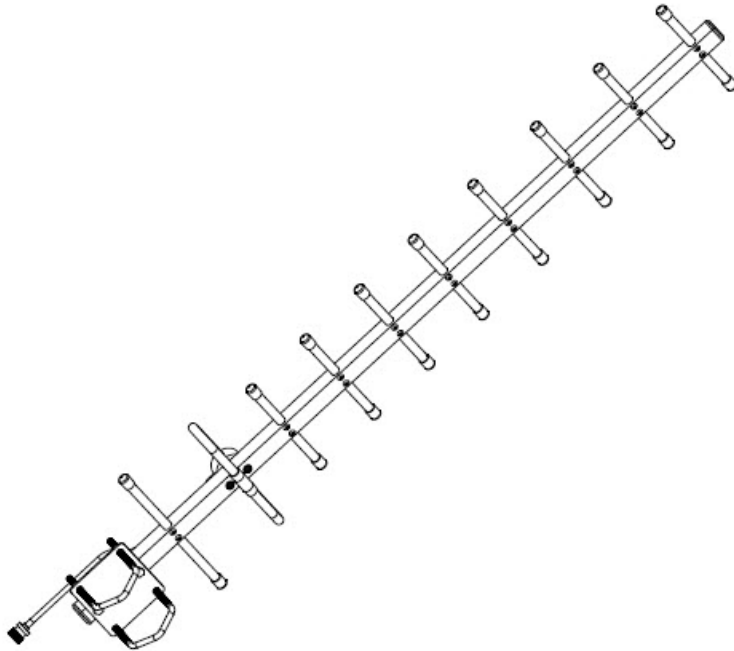

V-shape Bolts for Pole Dia
 $\varnothing 30\text{mm} \sim \varnothing 50\text{mm}$

Images supplémentaires

2D Radio Pattern Model: ANT-868-12.5dbi-Yagi 10 Elements

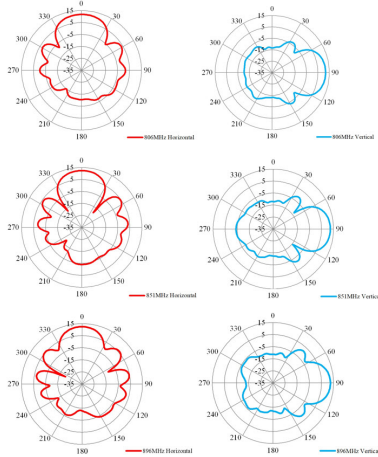

VSWR and Return Loss Model: ANT-868-12.5dbi-Yagi 10 Elements

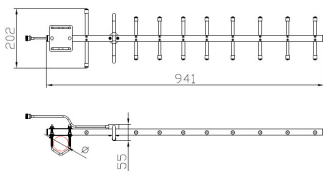
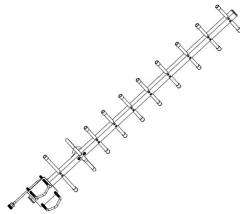
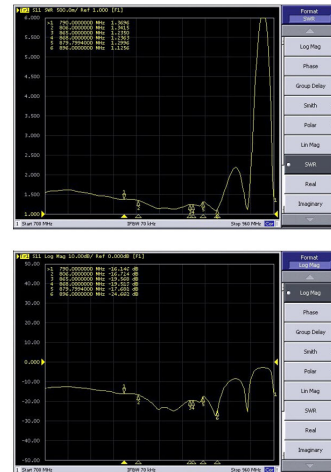

V-shape Bolts for Pole Dia
 $\varnothing 30\text{mm} - \varnothing 53\text{mm}$

Accessoires

No. d'article	Désignation
177056	ALLNET Antennen-Kabel LMR-195 R-SMA(m) <> N-Type(m) 1000 cm
88874	ALLNET Antennenkabel LMR-195 R-SMA - N-Type 1,5 Meter
88875	ALLNET Antennenkabel LMR-195 R-SMA - N-Type 3,0 Meter
88876	ALLNET Antennenkabel LMR-195 R-SMA - N-Type 5,0 Meter
88877	ALLNET Antennenkabel LMR-195 R-SMA - N-Type 7,0 Meter



No. d'article: 208619
Numéro de fabricant: ANT-868-12.5dbi-Yagi

No. d'article	Désignation
90403	ALLNET Antennen-Kabel LMR-195 N-Type(m) <> N-Type(m) 150 cm
90404	ALLNET Antennen-Kabel LMR-195 N-Type(m) <> N-Type(m) 300 cm
90405	ALLNET Antennen-Kabel LMR-195 N-Type(m) <> N-Type(m) 500 cm
93748	ALLNET Antennen-Kabel N-Type Stecker/Stecker, RG-8, 1m,
93749	ALLNET Antennen-Kabel N-Type Stecker/Stecker, RG-8, 2m,
93750	ALLNET Antennen-Kabel N-Type Stecker/Stecker, RG-8, 3m,
93751	ALLNET Antennen-Kabel N-Type Stecker/Stecker, RG-8, 5m,
93752	ALLNET Antennen-Kabel N-Type Stecker/Stecker, RG-8, 7m,
78202	ALLNET Antenne Blitzschutz, 5,8GHz N-Type Bu/St.