

SYNERGY 21

※ Features:

1. Package: 3.5*2.8*1.9mm (TOP view white LED)
2. Emitted Color: White
3. Mono-color type
4. Soldering methods: All SMT assembly methods
5. Comply ROHS standard.

※ Applications:

1. LCD back light.
2. Mobile phones: LCD,
3. Status indicators: Consumer & industrial electronics.
4. General use.

※→Package Outline Dimension:

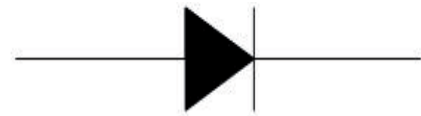
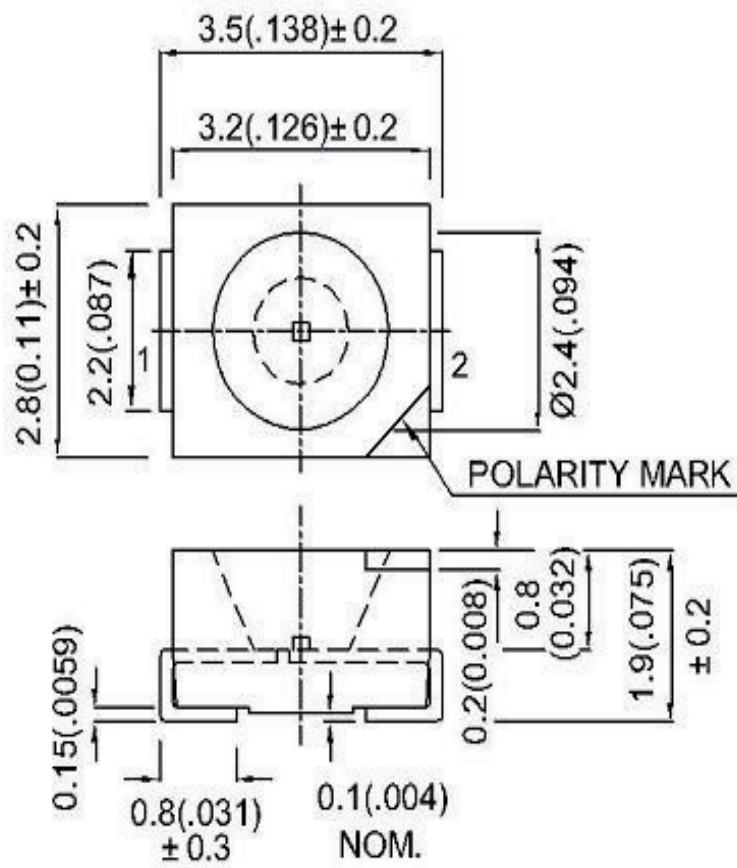

NOTES:

1. All dimensions are in millimeters (inches).
2. Tolerance is ±0.10mm unless otherwise specified.
3. Specifications are subject to change without notice.

SYNERGY 21

※ Absolute Maximum Ratings(Ta=25°C)

Parameter	Symbol	Rating	Unit
Power Dissipation	Pd	100	mW
Forward Current	I _F	20	mA
Peak Forward Current * 1	I _{FP}	100	mA
Reverse Voltage	V _R	5	V
Soldering Temperature	Tsol	260 (for 5 seconds)	°C
Operating Temperature	Topr	-30°C~85°C	-
Storage Temperature	Tstg	-40°C~85°C	-
Electrostatic discharge	ESD	2000	V

* 1 I_{FP} condition: pulse of 1/10 duty and 0.1ms width.

※ Electrical-optical characteristics(Ta=25°C)

Parameter	Symbol	Min.	Typ.	Max.	Unit	Condition
Forward Voltage	V _f	3.0	3.2	3.4	V	I _F =20mA
Luminous Intensity	L _m	4	4.5	5	lm	
Luminous Intensity	I _v	1500		2000	mcd	
Viewing Angle	2θ _{1/2}	-	120		deg	
Reverse Current	I _R		-	5	μA	V _R =5V

Note: 1. Tolerance of luminous intensity is ±10%

2. Tolerance of forward voltage is ±0.05V

※ Typical Electro-Optical Characteristics Curves

SYNERGY 21

Relative intensity vs. wavelength(Ta=25°C)

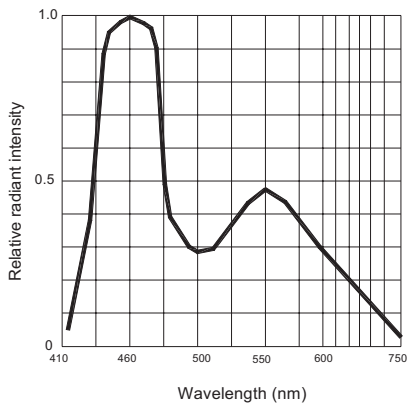

Forward current derating curve vs. ambient temperature

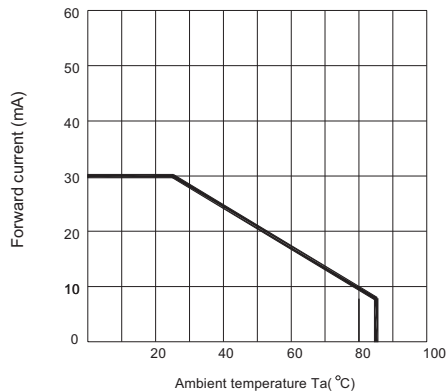

Forward current vs. forward voltage(Ta=25°C)

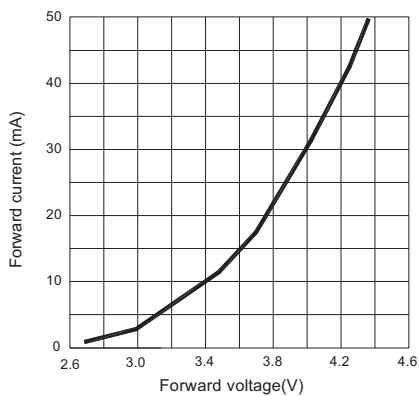

Luminous intensity vs. ambient temperature

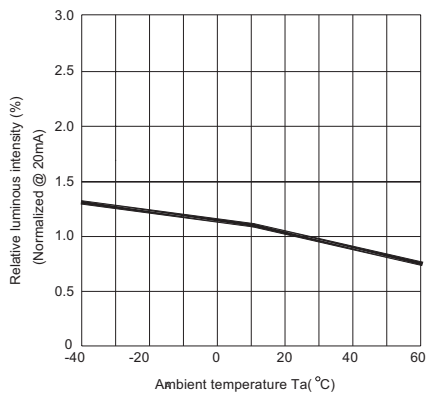

Relative luminous intensity vs. forward current

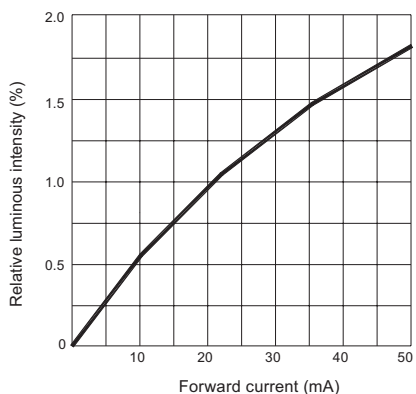

Radiation diagram

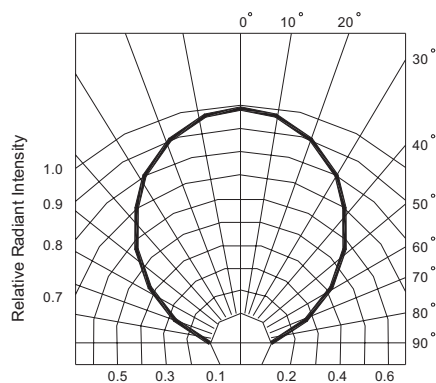

※ Judgment criteria of failure for the reliability

- Iv: Below 50% of initial values
- Vf: Over 20% of upper limit value
- IR: Over 2 times of upper limit value

Note: Measurement shall be taken between 2 hours and after the test LED have been returned to normal ambient conditions after completion of each test.

※ Precautions for use :

1. Customer must apply the current limiting resistor in the circuit so as to drive the LEDs within the rated current. Otherwise slight voltage shift maybe will cause big current change and burn out will happen.
2. Also, caution should be taken not to overload the LEDs with instantaneous high voltage at the turning ON and OFF of the circuit.
3. Storage:
 - 3.1 Don't open the moisture proof bag before ready to use the LEDs.
 - 3.2 The LEDs should be kept at 30°C or less and 60%RH or less before opening the package. The max. storage period before opening the package is 1 year.
 - 3.3 After opening the package, the LEDs should be kept at 30°C/35%RH or less, and it should be used within 7 days.
 - 3.4 If the LEDs be kept over the conditions of 3.4, baking is required before mounting. Baking condition as below: $60 \pm 5^\circ\text{C}$ for 12 hrs.
4. Soldering condition:
 - 4.1 Manual of soldering:

The temp. of the iron should be lower than 280°C and soldering within 3sec per solder-pad is to be observed.
 - 4.2 Pb-free solder temp. -time profile

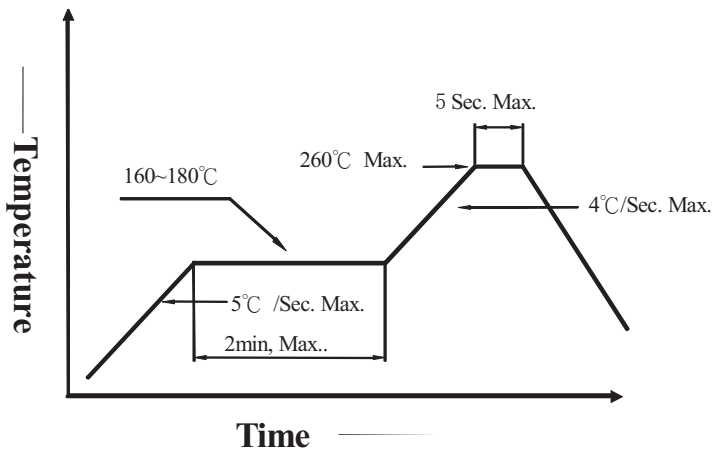

4.3 DIP soldering (Wave Soldering) temp. -time profile:

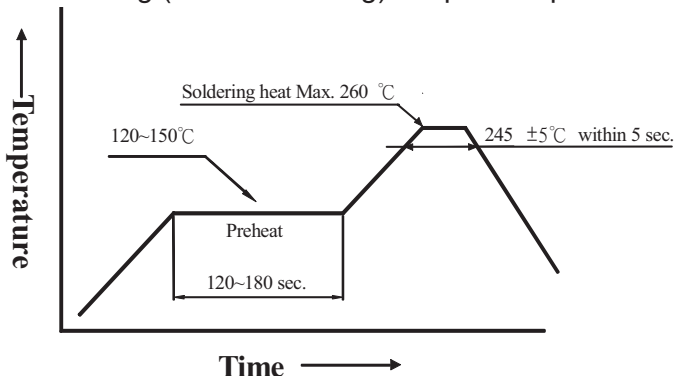

SYNERGY 21

- Note: a) Reflow soldering should not be done more than two times.
b) Don't put stress on the LEDs when soldering.
c) Don't warp the circuit board before it have been returned to normal ambient conditions after soldering.

Loaded quantity: 2000 pcs/reel

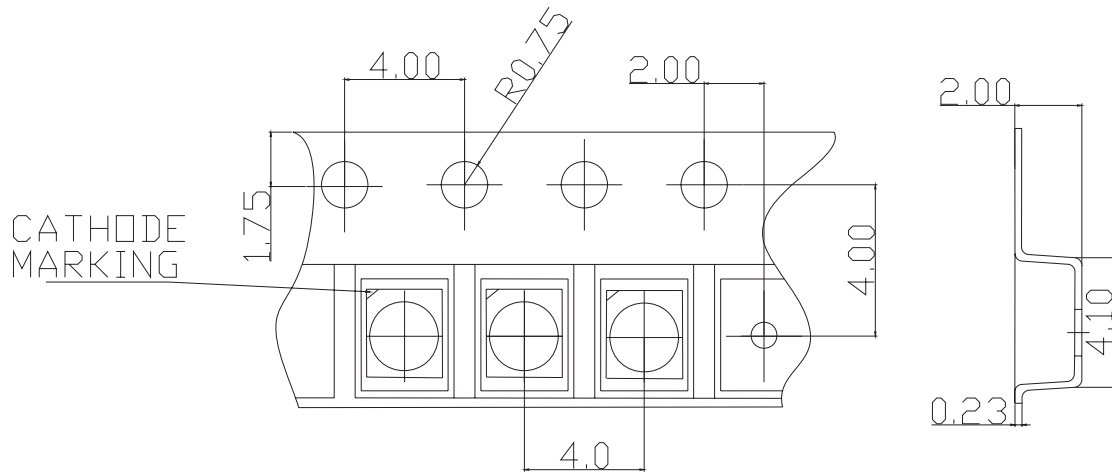

※ **Package Method:(unit:mm)**

